

**SEMESTRAL ASSESSMENT (1)
2016**

Section A	56
Section B	44
Your score out of 100	100
Parent's signature	

Name : _____ Index No: _____ Class: P 5 _____

10 May 2016 SCIENCE Attn: 1 h 45 min

SECTION A (28 X 2 marks)

For each question from 1 to 28, four options are given. One of them is the correct answer. Make your choice (1, 2, 3 or 4). Shade the correct oval on the Optical Answer Sheet.

1. Study the chart below.

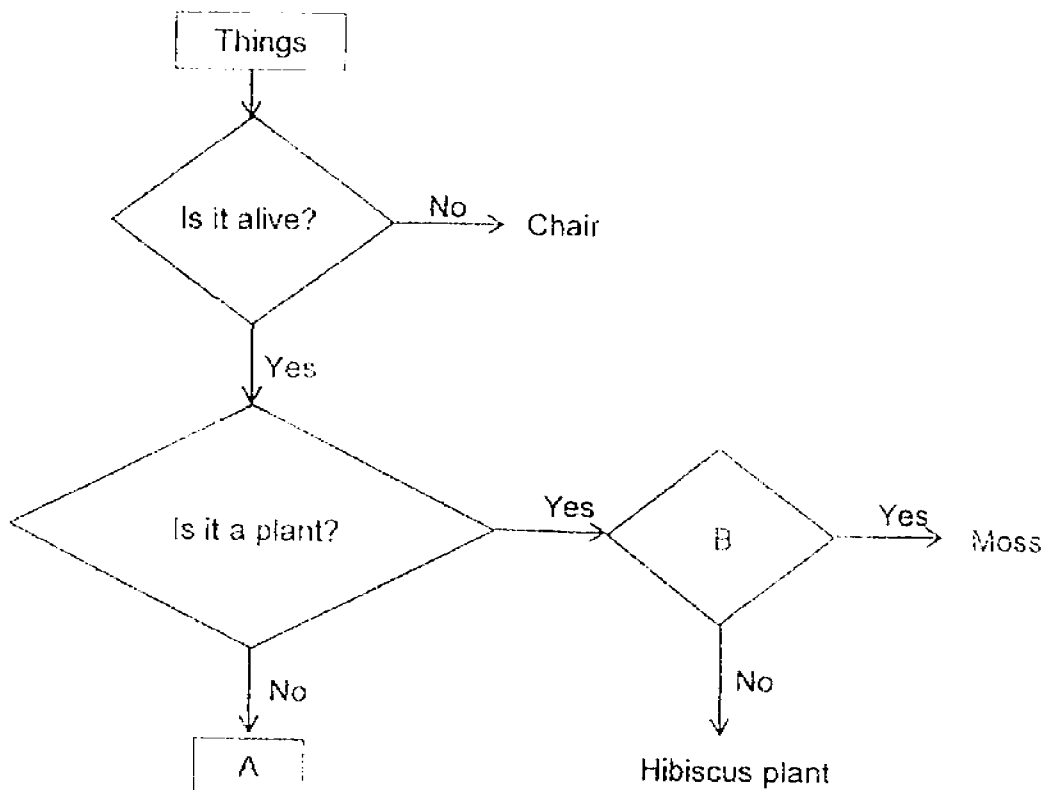

Which one of the following is correct?.

	A	B
(1)	Bacteria	Is it poisonous?
(2)	Toadstool	Does it reproduce from spores?
(3)	Algae	Does it make food?
(4)	Grass	Does it grow?

2. The table below shows the characteristics of animals P, Q, R and S. A tick (✓) indicates the presence of the characteristic in the animal.

Characteristic	Animal P	Animal Q	Animal R	Animal S
Live on land and in water	✓			
Body divided into three parts		✓		
Has hair			✓	
Has feathers				✓
Lays eggs	✓	✓	✓	✓

Which one of the following represents animals P, Q, R and S correctly?

	Amphibian	Bird	Insect	Mammals
(1)	P	S	Q	R
(2)	P	Q	S	R
(3)	Q	R	P	S
(4)	S	P	R	Q

3. Study the animals below.

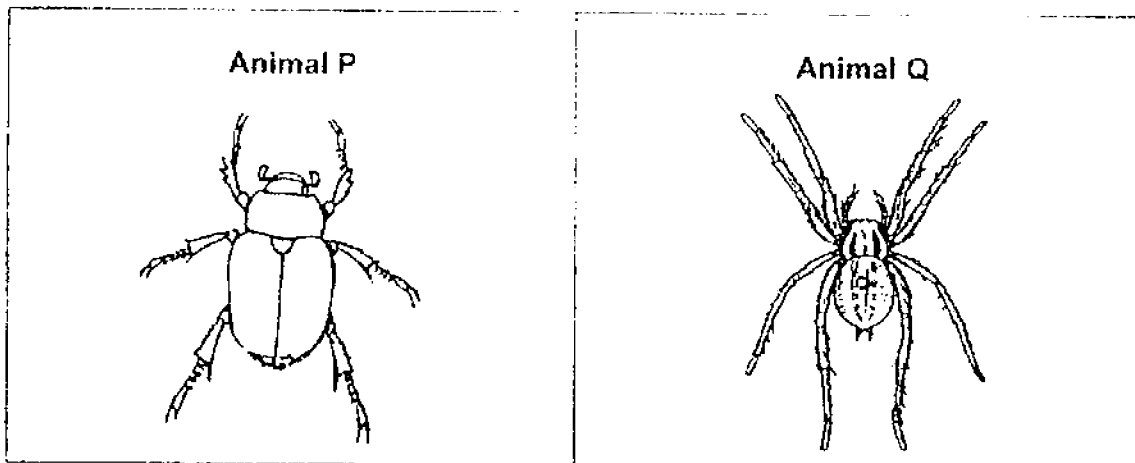

Based on the diagrams, which of the following statements is/are correct?

- A Both animals are insects.
 - B Both animals have eight legs.
 - C Animal P is an insect but not animal Q.
 - D Both animals have bodies divided into three parts.
- (1) C only
 (2) A and D only
 (3) B and C only
 (4) A, C and D only



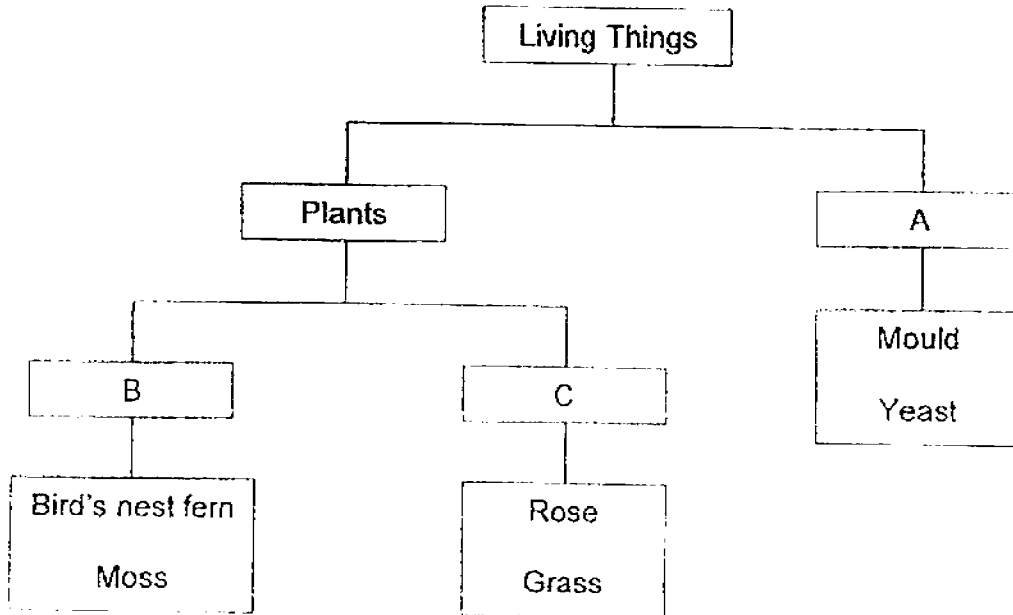

4. Study the classification table below.

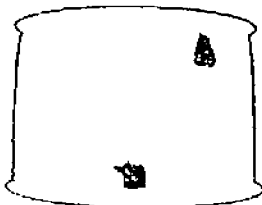

Which one of the following identify A, B and C correctly?

	A	B	C
(1)	Fungi	Pollinated by wind	Pollinated by animals
(2)	Fungi	Non-flowering plants	Flowering plants
(3)	Non-flowering plants	Reproduce by spores	Reproduce by seeds
(4)	Non-flowering plants	Dispersed by wind	Dispersed by animals

5. Sarah wanted to find out the conditions that affected the growth of bread mould. The table below shows the results of her experiment after 2 weeks.

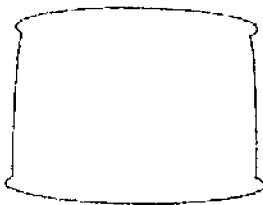
<p>Toasted bread kept in a room with a temperature of 31°C</p> 	<p>Bread kept in a room with a temperature of 31°C</p> 
<p>Toasted bread kept in a room with a temperature of 25°C</p> 	<p>Bread kept in a room with a temperature of 25°C</p> 
<p>Toasted bread kept in a freezer with a temperature of 0°C</p> 	<p>Bread kept in a freezer with a temperature of 0°C</p> 

Based on the results above, which one of the following statements is correct?

- (1) Mould only grows in an environment that has no light.
- (2) Moisture needed for moulds to grow is absent in toasted bread.
- (3) Mould will not grow if the temperature of the environment is 0°C .
- (4) Mould only grows if the temperature of the environment is 20°C and above.

6. The diagram below shows the stages in the life cycle of a butterfly.

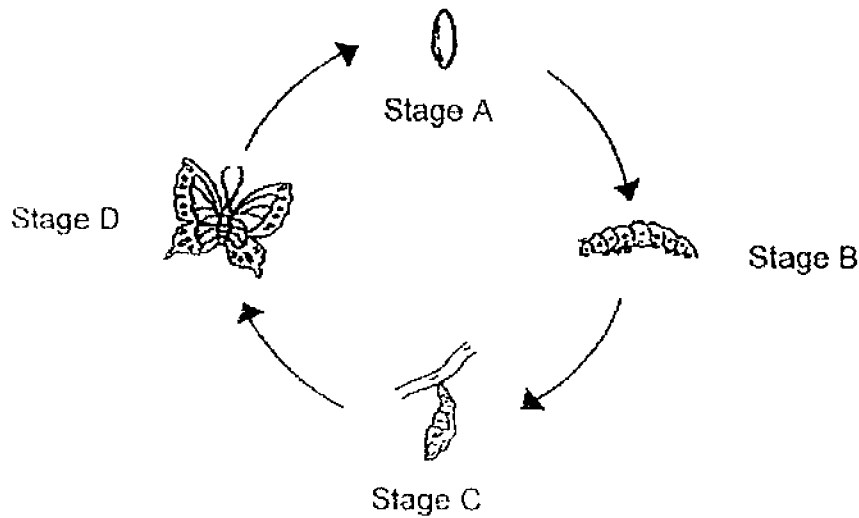

Which of the following statements are correct?

- A It moults at Stage B.
- B It is a pupa at Stage A.
- C It is a larva at Stage B.
- D It stops eating at Stage C.

- (1) A and C only
- (2) A and D only
- (3) C and D only
- (4) A, B, C and D

7. The table below shows the physical characteristics of Cat A and Cat B.

<u>Cat A</u>	<u>Cat B</u>
<ul style="list-style-type: none"> • Male • Pink nose • Short-tailed • Black and white fur 	<ul style="list-style-type: none"> • Female • Black nose • Short-tailed • White fur

Based on the information above, what are the physical characteristics most likely displayed by the offspring of Cat A and B?

- (1) Brown nose, long-tailed, grey fur
- (2) Grey nose, long-tailed, brown fur
- (3) Black nose, short-tailed, brown fur
- (4) Pink nose, short-tailed, black and white fur

8. The diagram below shows the different stages of seed germination.

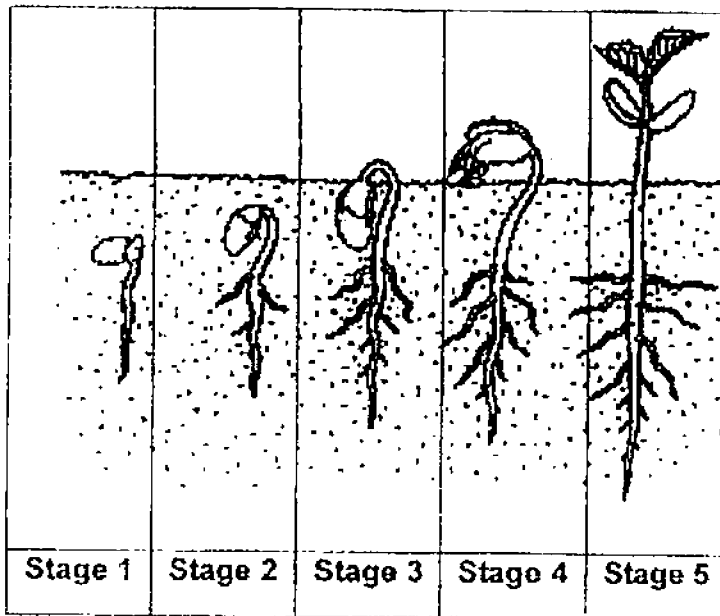

Which of the following statements is/are correct?

- A The seedling needs sunlight at Stage 1.
- B The seedling is able to make its own food at Stage 5.
- C The seedling gets its food from the seed coat in Stage 2.
- D The seed leaves provide food for the seedling at Stage 3.

- (1) A and C only
- (2) A and B only
- (3) B and D only
- (4) A, B and D only

9. Which one of the following characteristics can be passed on from parents to their offsprings?

- (1) height, length of nail, lobed ears
- (2) colour of hair, face shape, freckles
- (3) freckles, length of hair, texture of hair
- (4) colour of eyes, ability to roll tongue, length of hair

10. The diagram below shows a process in the human reproduction.

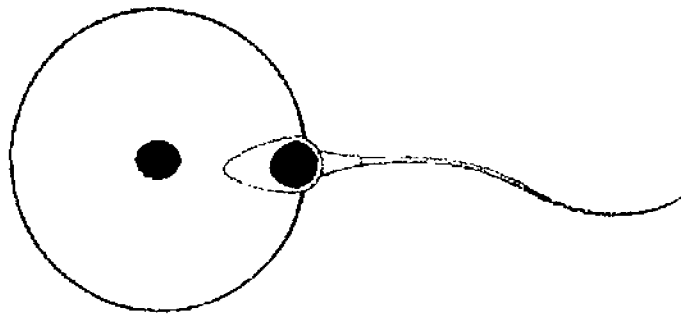

Which of the following are true about the process?

- A It takes place in the womb of the female.
 - B It happens after division of cells take place.
 - C It involves the fusing of an egg cell and a sperm.
 - D Genetic information from the male and female adults are passed on to their young.
- (1) A and C only
 - (2) C and D only
 - (3) A, B and C only
 - (4) B, C and D only

11. The table below compares the reproductive systems in a human and a plant.

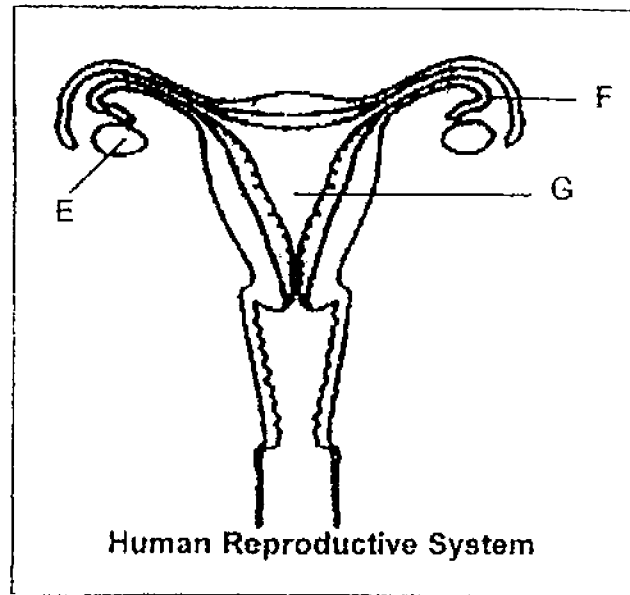
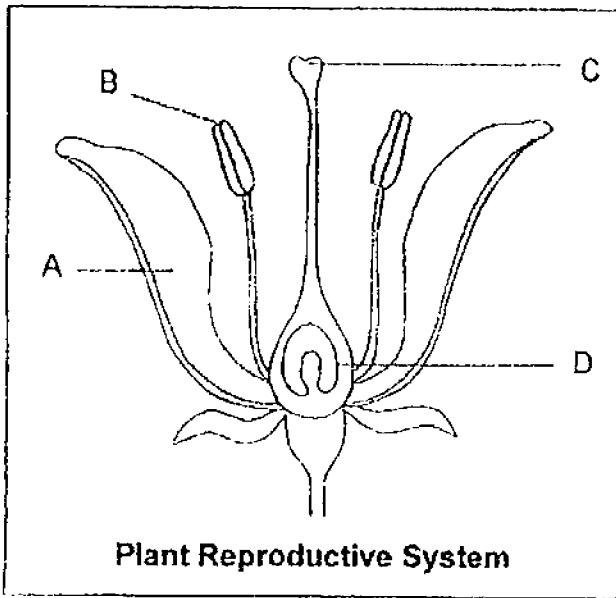

	Where female reproductive cell is produced		Where fertilisation takes place	
	Human	Plants	Humans	Plants
(1)	E	D	F	D
(2)	F	B	E	C
(3)	G	A	G	D
(4)	E	C	F	B

12. The diagrams below show the human male reproductive system and the plant reproductive system.

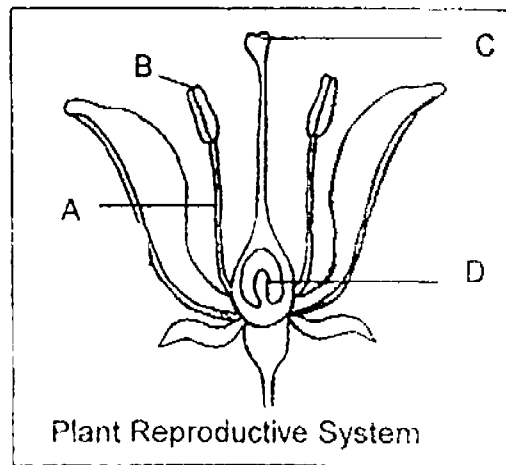
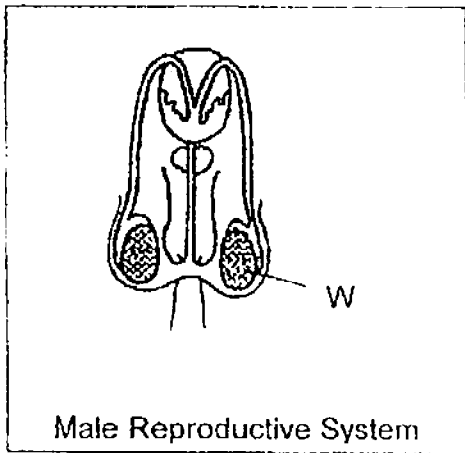

Which of the following part has a similar function as part W in the male reproductive system.

- (1) A
- (2) B
- (3) C
- (4) D

13. The diagram below shows the different stages in the life cycle of a flowering plant.

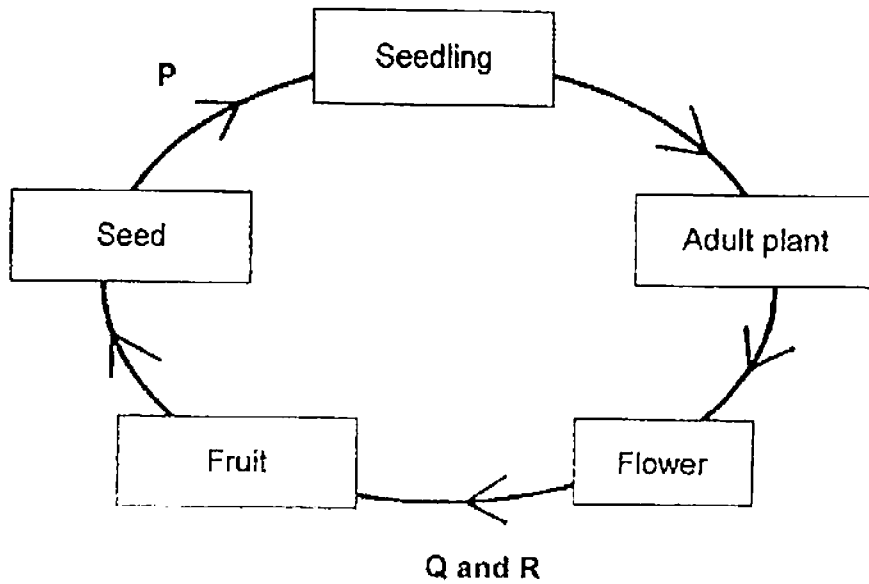

Which one of the following correctly identifies processes P, Q and R?

	P	Q	R
(1)	Germination	Pollination	Fertilisation
(2)	Fertilisation	Germination	Pollination
(3)	Pollination	Fertilisation	Germination
(4)	Fertilisation	Pollination	Germination

14. Ken wanted to find out if butterflies are attracted to red or white flowers. He used some red and white flowers and sprayed some of them with 10 cm³ of sugar solution.

Which of the following set-ups should he use in order to carry out a fair test?

(1)

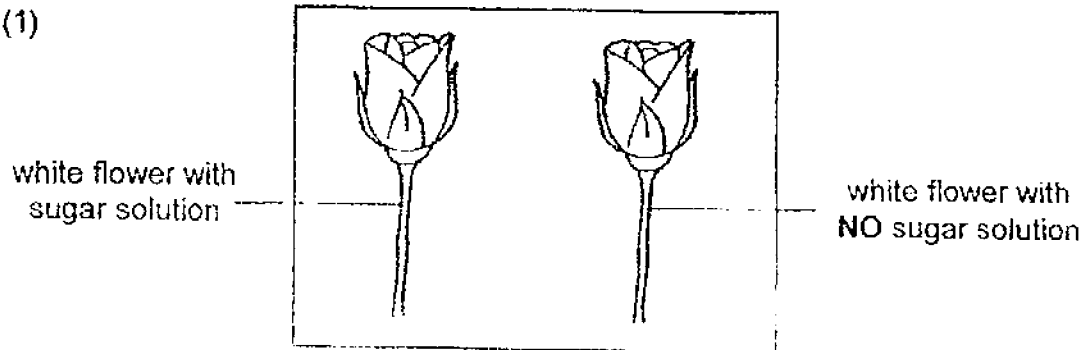

(2)

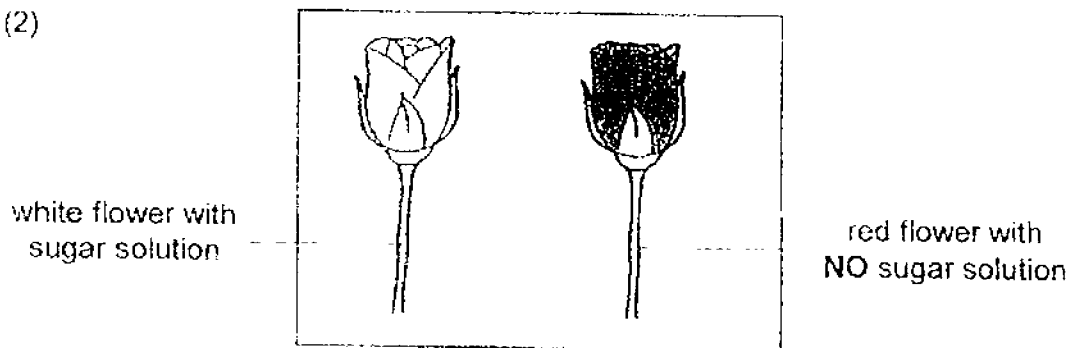

(3)

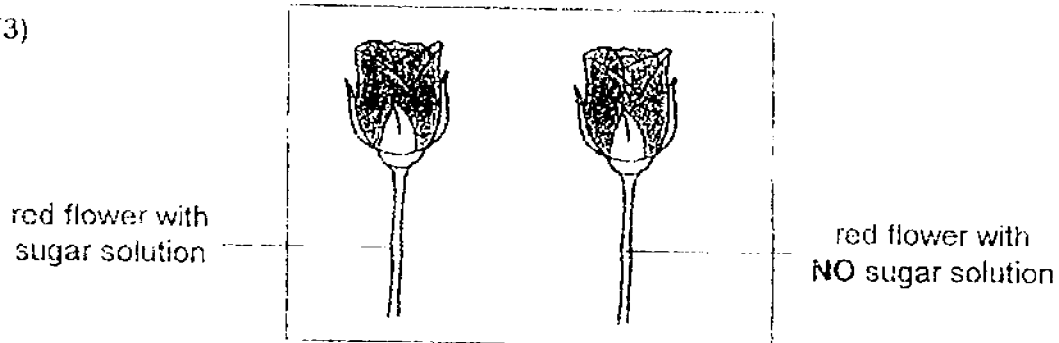

(4)

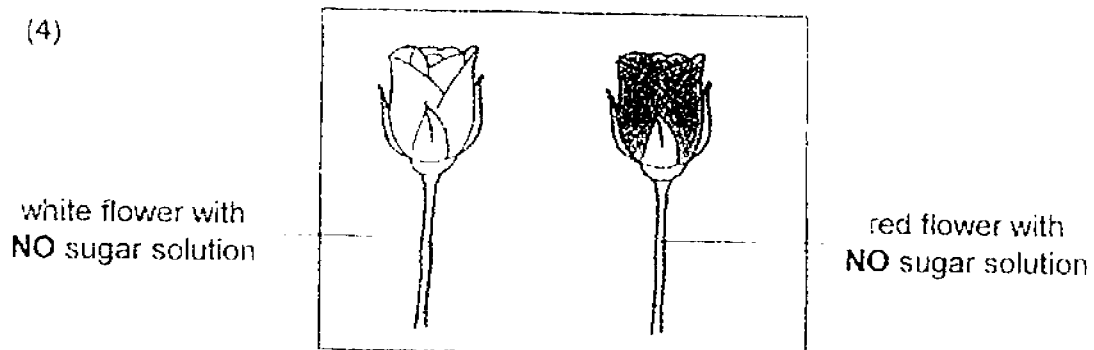

15. The diagram below shows four different cells, A, B, C and D.

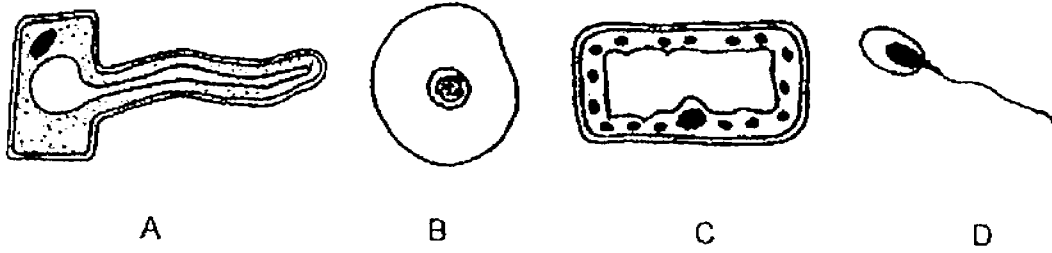

Which of the following is/are animal cell(s)?

- (1) B only
- (2) B and D only
- (3) A and C only
- (4) A, B and D only

16. Study the flow chart below.

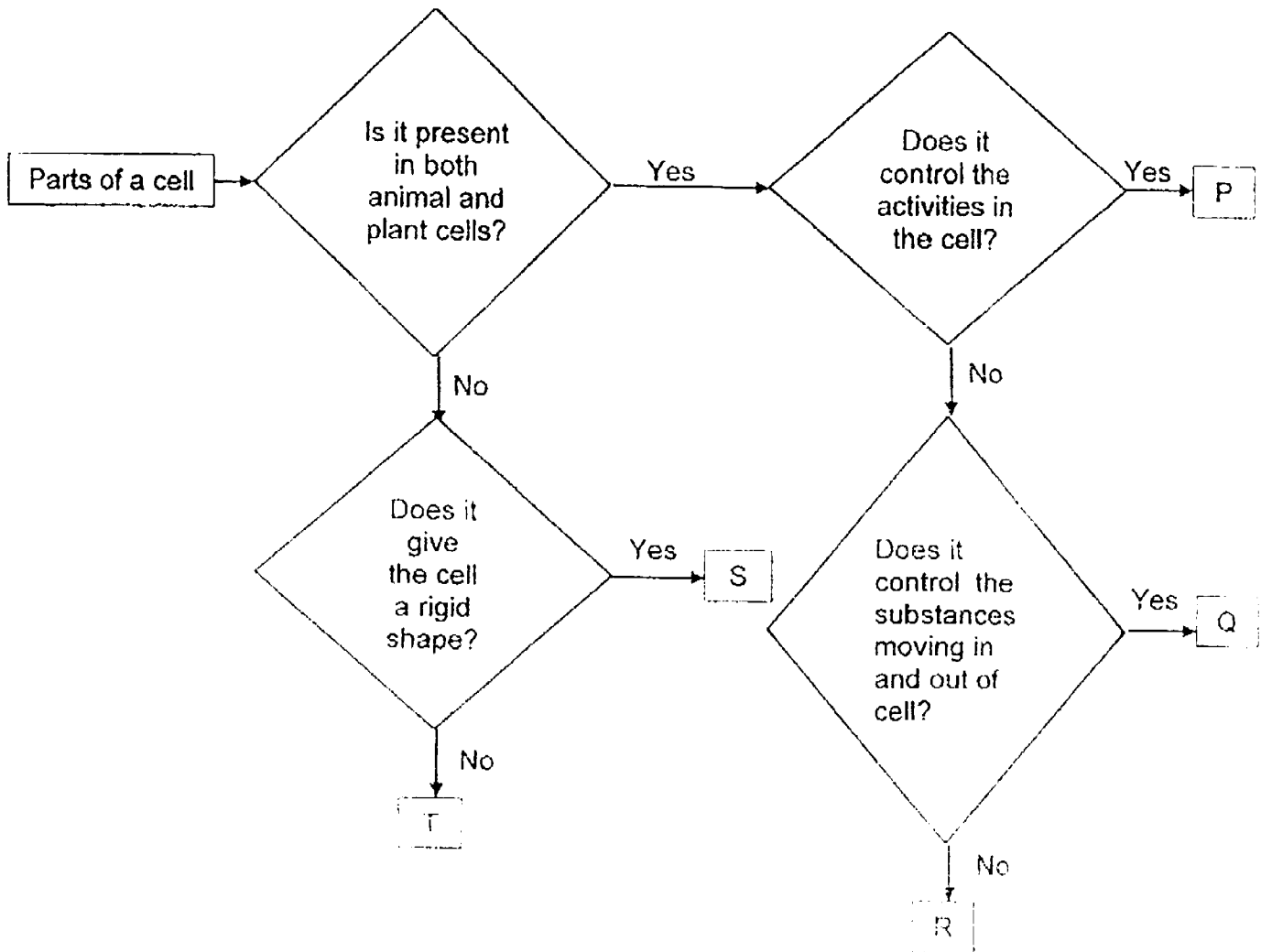

Which part, P, Q, R, S or T matches part A and B of the cell below?

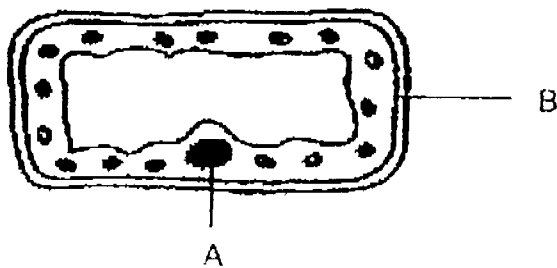

	Part A	Part B
(1)	T	S
(2)	P	Q
(3)	Q	T
(4)	R	R

17. Siti hung 5-g weights onto 3 strings made of different materials. The strings were the same lengths and thickness. She continued to add 5-g weight onto each of the string and recorded the maximum number of weights that each string could hold before it broke.

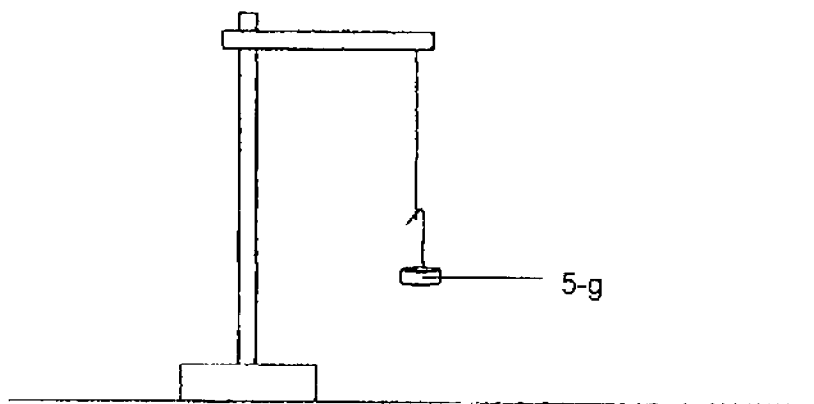

Which property of materials was Siti testing?

- (1) strength
 - (2) flexibility
 - (3) waterproof
 - (4) transparency
18. The diagram below shows a picture of a life jacket

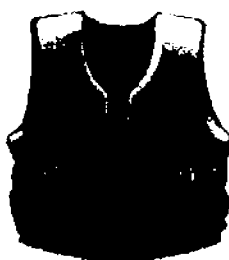

The table below shows the physical properties of Materials A, B and C. A tick (✓) indicates the physical property of the material.

Material	Physical Property		
	Strong	Flexible	Waterproof
A			
B			
C			
D			

Based on the information given in the table, which one of the following materials is best used for making the life jacket?

- (1) A
- (2) B
- (3) C
- (4) D

19. Two objects are placed on a balance as shown below.

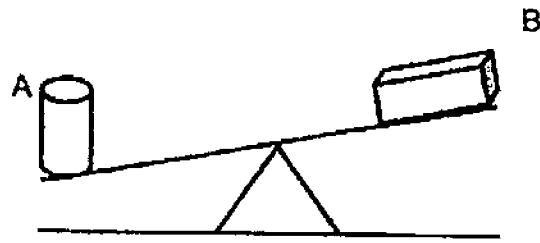

Based on your observation of the diagram above, which one of the following statements is correct?

- (1) A has more mass than B
- (2) A has more volume than B
- (3) A and B cannot be compressed
- (4) A and B are made of different materials

20. The diagram below shows the water cycle.

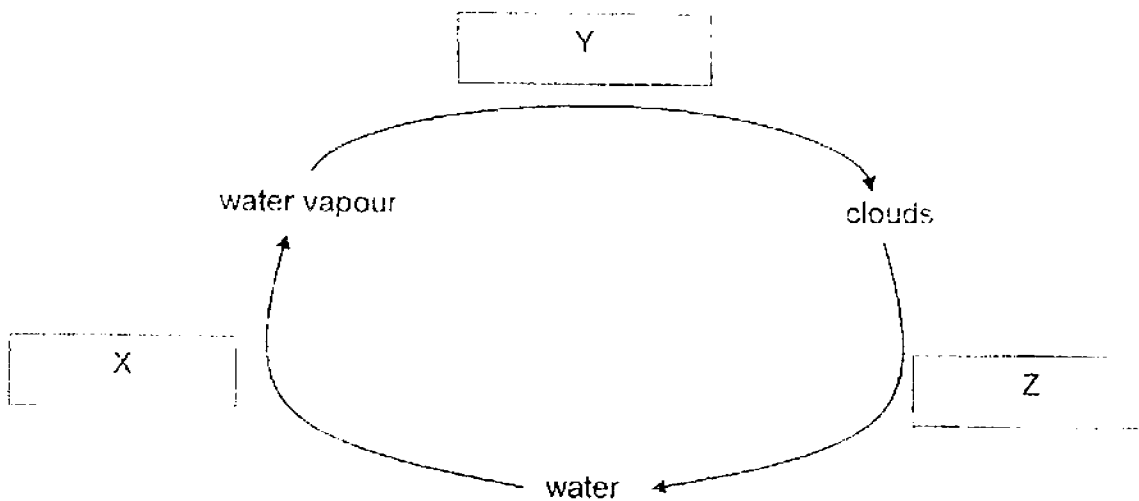

What do the letters X, Y and Z in the boxes stand for?

	X	Y	Z
(1)	evaporation	rain	condensation
(2)	evaporation	condensation	rain
(3)	condensation	evaporation	rain
(4)	condensation	rain	evaporation

21. The flow chart is used to classify items, X, Y and Z.

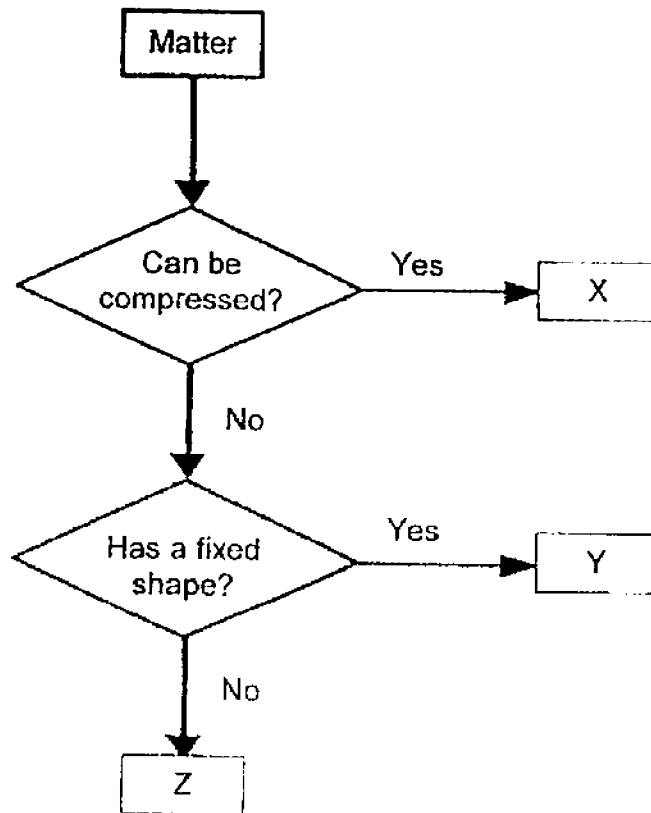

Which one of the following correctly identifies oil, cup and water vapour?

	Oil	Cup	Water vapour
(1)	Z	Y	X
(2)	Y	X	Z
(3)	Z	X	Y
(4)	Y	Z	X

22. Peter poured 300cm^3 of water into each of the containers shown below which were made of the same material. The containers were left in the garden.

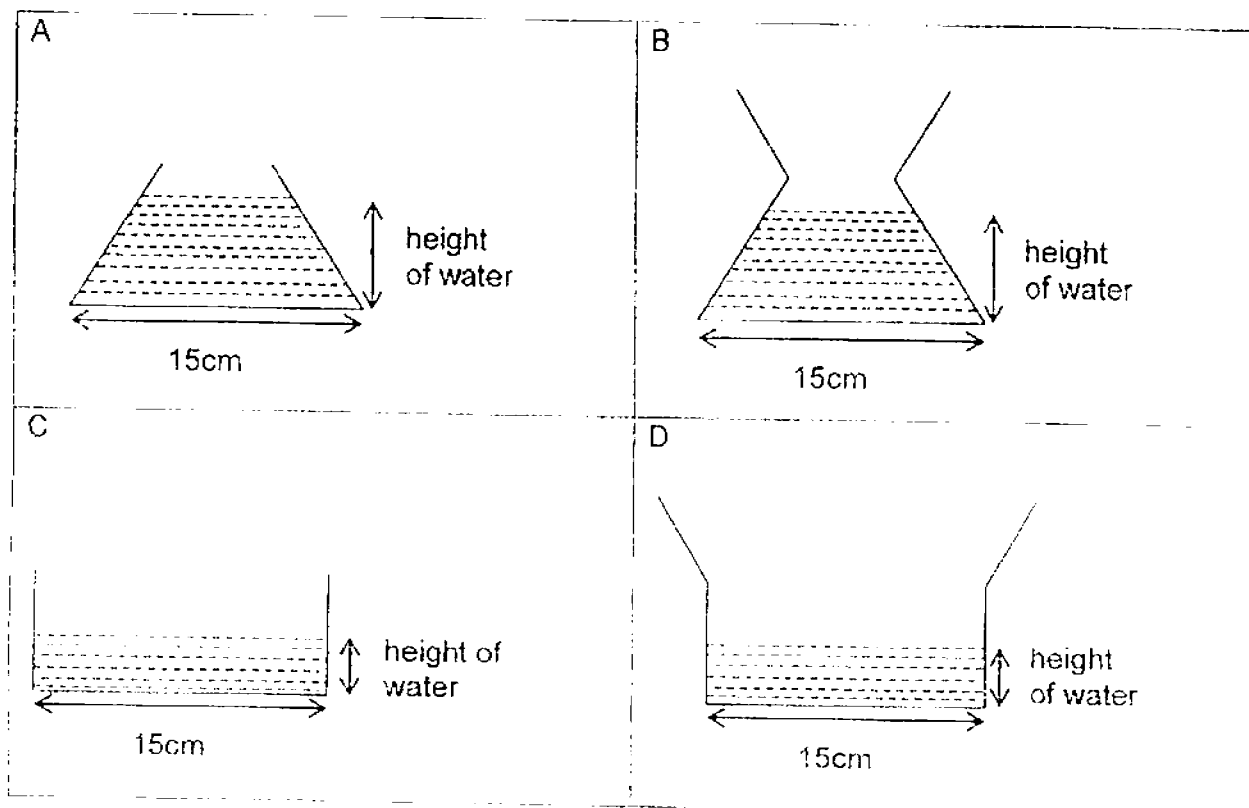

Which of the following containers would have the least amount of water left after a few hours?

- (1) A and D only
- (2) A and B only
- (3) B and C only
- (4) C and D only

23. Substance P melts at 65°C and boils at 600°C . Which one of the following shows the state of substance P at 50°C and 550°C respectively?

State of substance P at	
50°C	550°C
(1) solid	liquid
(2) solid	gas
(3) liquid	liquid
(4) liquid	gas

24. In the kitchen, Ali heated a pot of ice cubes until it started to boil. Then he continued to let it boil for another 10 minutes.

Which one of the following graphs below shows the changes in the temperature of the water correctly?

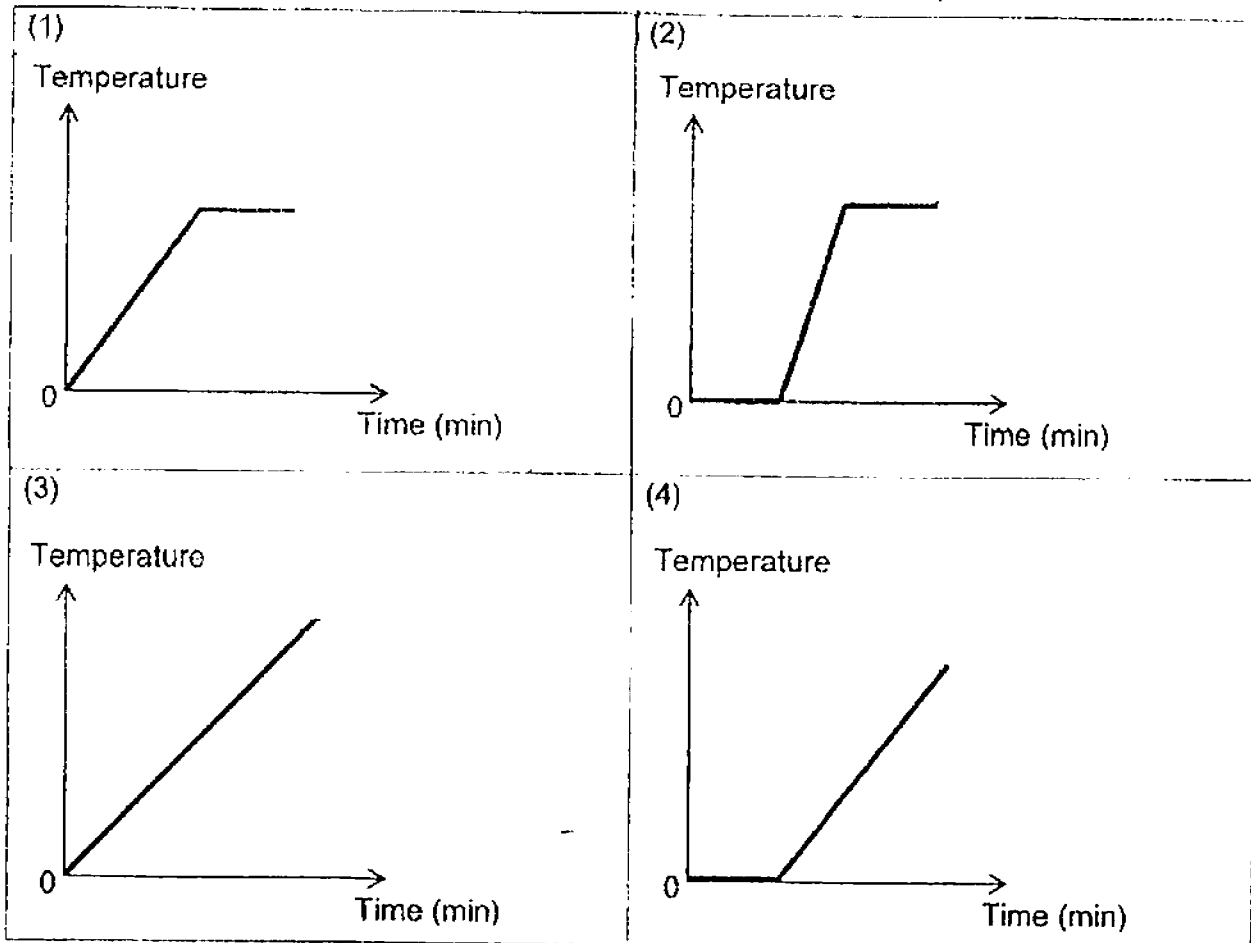

25. A ball was placed between a lighted torch and a screen as shown below.

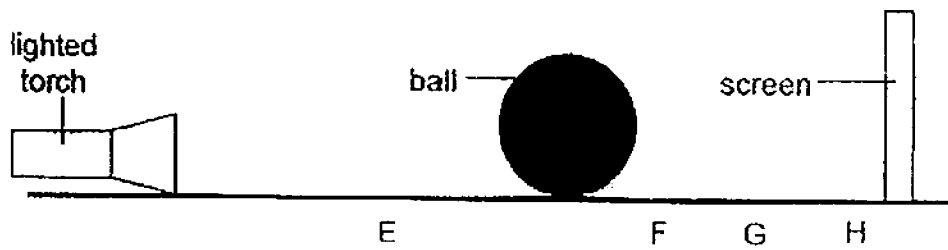

A ball was placed as shown in the diagram above. A heart-shaped cardboard could be placed in positions E, F, G or H, to obtain the shadow as shown below.

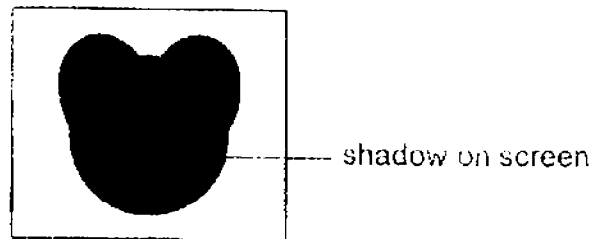
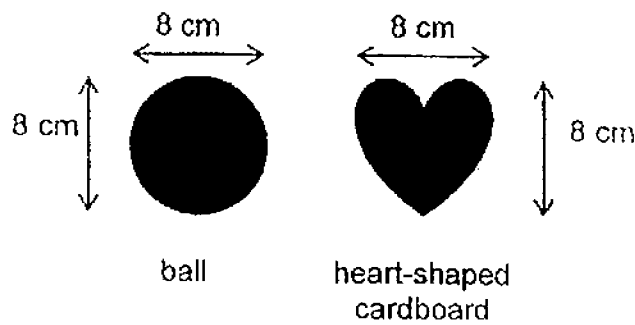

Which one of the following positions was the heart-shaped cardboard placed?

- (1) E
- (2) F
- (3) G
- (4) H

26. Three objects, W, X and Y, that were of identical size and shape, were placed between a lighted torch and a screen as shown below.

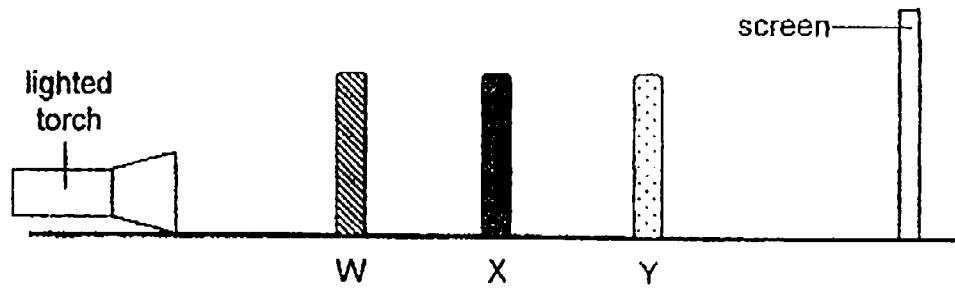

The following diagram shows the shadow cast on the screen.

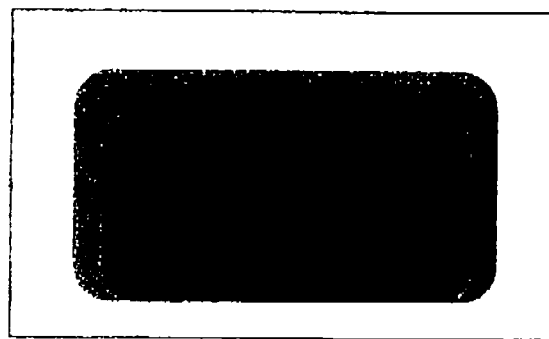

Based on the above observation, which one of the following most likely describes the degree of transparency of objects, W, X and Y?

	W	X	Y
(1)	translucent	opaque	transparent
(2)	opaque	transparent	translucent
(3)	translucent	translucent	opaque
(4)	opaque	opaque	transparent

27. Johnny placed a glass of hot water into a basin filled with tap water.

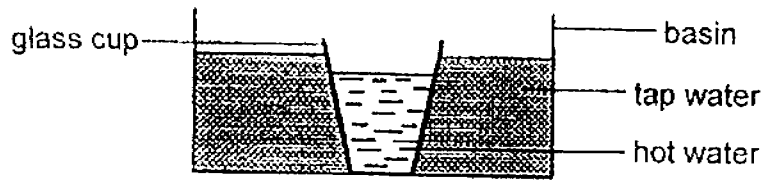

Which of the following statements are true as Jonny placed the set-up in a kitchen for 5 minutes?

- A The tap water lost heat to the hot water.
- B The temperature of the tap water increased.
- C The temperature of the hot water increased.
- D The hot water lost heat to the surrounding air.

- (1) A and C only
- (2) A and D only
- (3) B and C only
- (4) B and D only

28. Containers W, X, Y and Z are made of different materials A, B, C and D. The containers are of the same size and thickness. Same amount of water was poured into each container and heated with the same amount of heat.

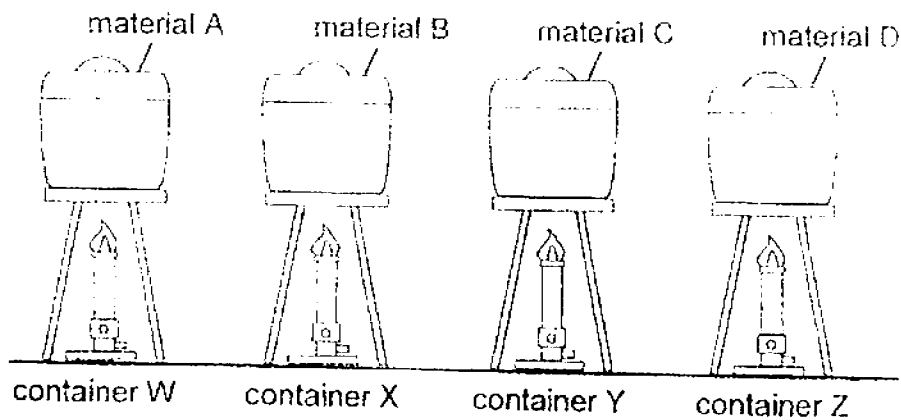

The table below shows the time taken for the water in each container to boil.

	Container W	Container X	Container Y	Container Z
Time taken for the water to boil	40 min	15 min	65 min	35 min

Which material is the best conductor of heat?

- (1) A
- (2) B
- (3) C
- (4) D

Name: _____ Index No: _____ Class: P5

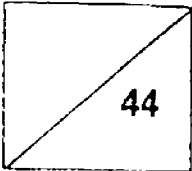

SECTION B (44 marks)

For questions 29 to 41, write your answers clearly in the spaces provided.
The number of marks is shown in brackets [] at the end of each question or part question.

29. Study the diagrams below.

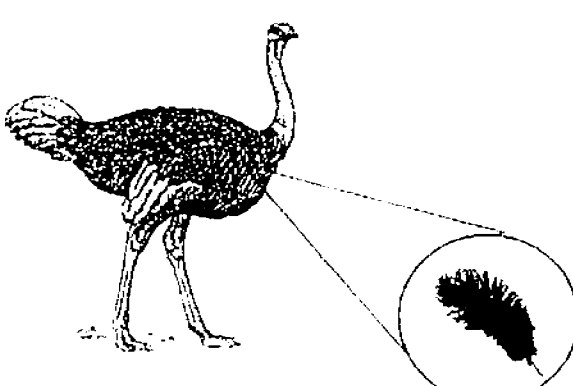
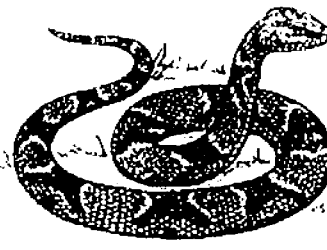
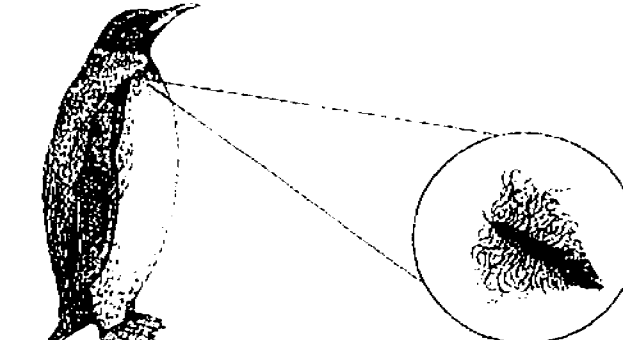
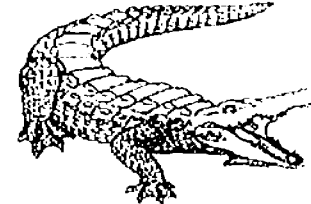
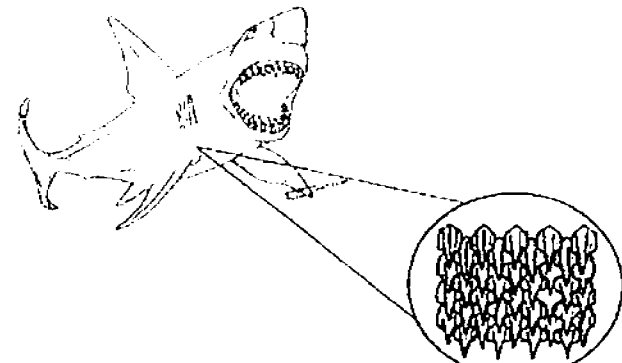
 <p>Animal P</p>	 <p>Animal Q</p>
 <p>Animal R</p>	 <p>Animal S</p>
 <p>Animal T</p>	

Continue from Question 29

Classify Animals P, Q, R, S and T correctly in the table below.

[3]

Bird	Fish	Reptile

SCORE	3
-------	---

30. The diagram below shows the life cycles of the cockroach and mosquito.

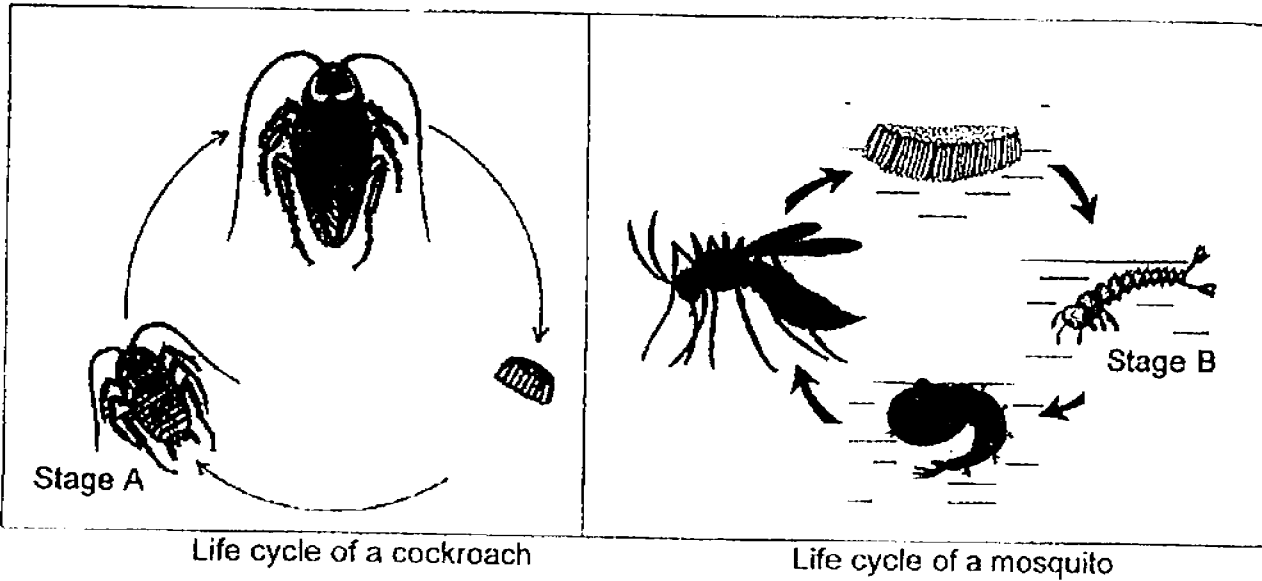

(a) State 2 differences between the animals shown at Stage A and Stage B. [2]

(b) Based on the life cycle of the mosquito above, name the stage(s) which is/are most challenging to get rid of the mosquitoes. Explain your answer clearly. [1]

SCORE	3
-------	---

31. Ali wanted to find out if water is needed for seeds to germinate.

(a) Which of the following variables should he keep constant in his experiment? [1]

Put a tick (✓) in the correct boxes.

Variables	To be kept constant (✓)
Type of seeds used	
Number of seeds used	
Amount of water given to the seed	
Location of set-ups	

(b) Ali prepared a set-up by putting some of the healthy seeds into a pot of moist soil. Then he placed the set-up in a freezer. He told his friend that the seeds will germinate after a few days.

Do you agree with Ali? Explain your answer clearly. [2]

SCORE	3
-------	---

32. The diagram below shows Tom's family tree.

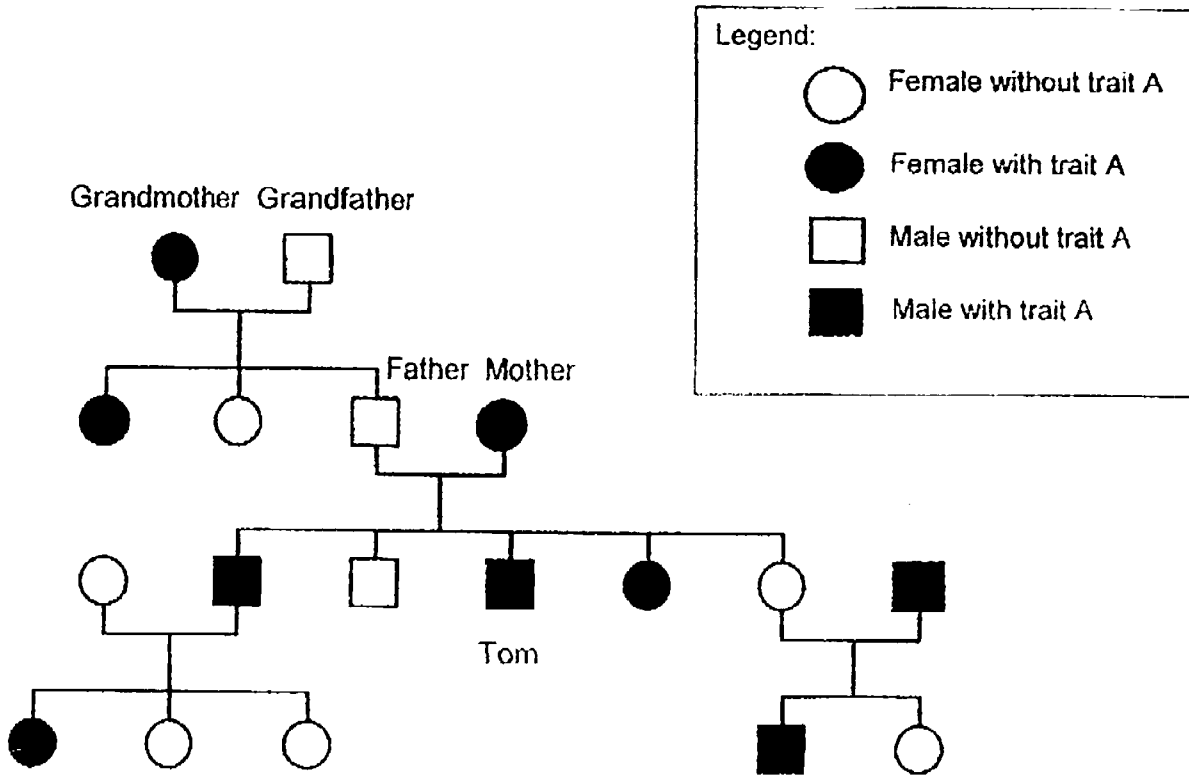

Based on the diagram above, answer the following questions.

(a) Who does Tom inherit trait A from? [1]

(b) How many of his siblings have inherited trait A? [1]

(c) Which part of the cell carries information of trait A that is passed on to the next generation? [1]

SCORE	3
-------	---

33. Mary wanted to investigate if the surface area of structure H of fruits A, B and C would affect the time taken by the fruits to reach the ground when dropped.

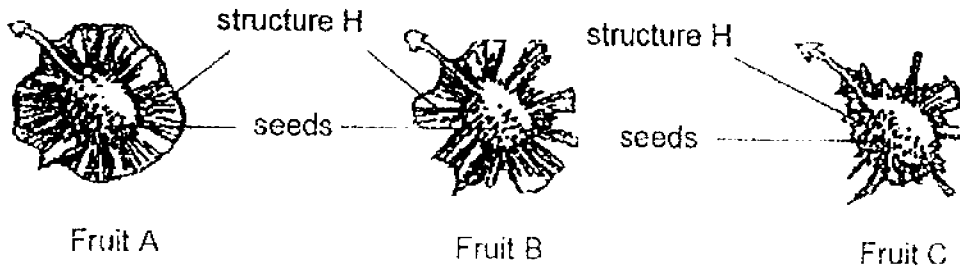

The fruits were released at the same time, 6 m above the ground. The time taken by each fruit to reach the ground is recorded in the table below.

Fruit	Time taken by the fruit to reach the ground (min)
A	2.6
B	1.3
C	0.9

- (a) Based on the results above, what is the relationship between the time taken by the fruits to reach the ground and the surface area of structure H of the fruit? [1]

SCORE	1
-------	---

Continue from Question 33

Mary studied the locations of three different plants, P, Q and R, on an area of land over time. The locations of the plants are shown on the maps below.

Legend:		
Plant P ▲	Plant Q ☆	Plant R ●

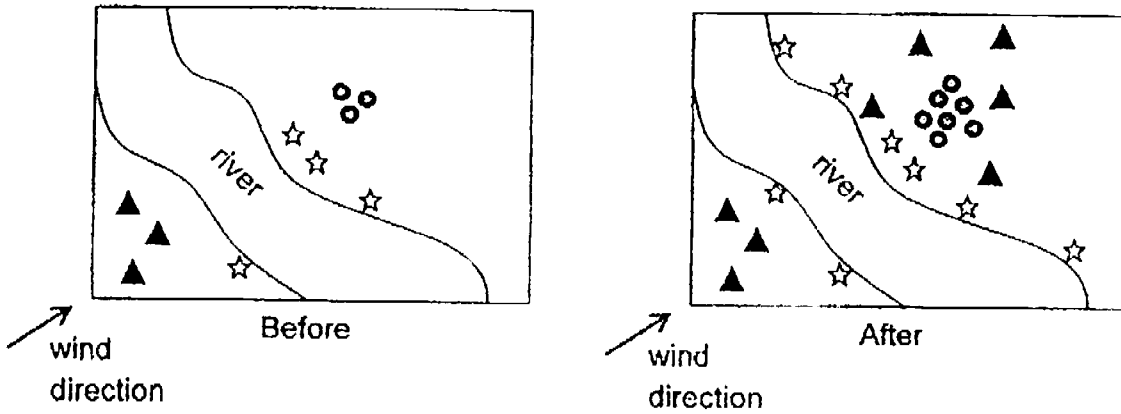

(b) Which plant is likely to have fruits with structure H? Explain your answer. [2]

(c) Besides having structure H, state another characteristic that the fruits, stated in your answer in (a), may have. [1]

(d) Which plant is likely to disperse its seeds by splitting? Give a reason for your answer. [1]

SCORE	4
-------	---

34. James observed cell X and Y, taken from some parts of a plant, under the microscope.

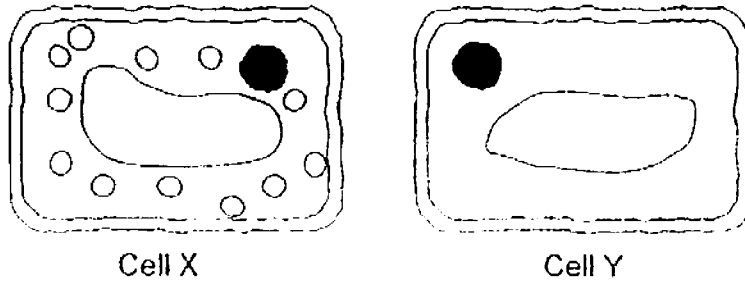

- (a) State an observable similarity between the cell X and Y. (Do not mention size and shape) [1]

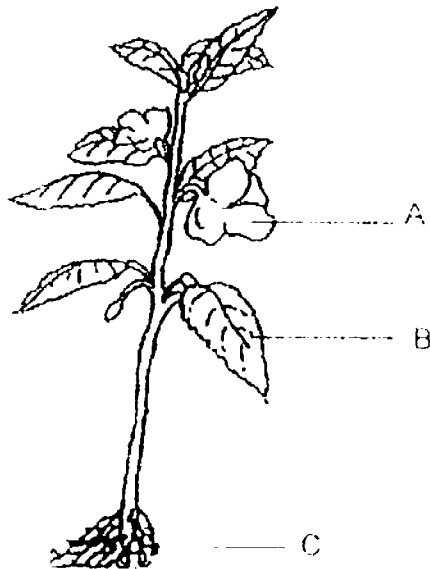

- (b) Is Cell X taken from part A, B or C of the plant? Explain your answer [2]

SCORE	3
-------	---

35. Alex wanted to find out the best type of glass to make a bottle to store olive oil. Olive oil is best stored away from light to preserve its taste.

He placed the glass sheets, A, B, C and D, of the same size at position X and shone a torch through it. The amount of light that passed through the glass was recorded in a datalogger as shown in the diagram below.

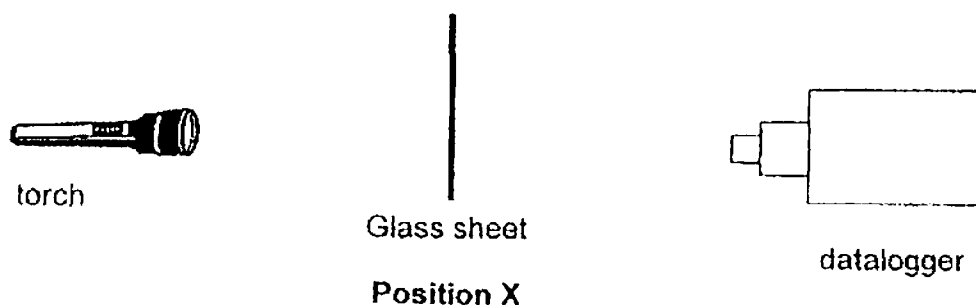

The amount of light detected from the torch, with the absence of glass sheet, was 50 units.

He repeated the experiment 3 times and recorded the average of the readings in in the graph below.

Glass sheet	Average amount of light detected (units)
A	10
B	48
C	35
D	40

Based on the information given, answer the following questions.

- (a) Why is it important for Alex to repeat his experiment 3 times? [1]



Continue from Question 35

- (b) Which kind of glass, A, B, C or D, should he use to make into bottles for storing olive oil? Give a reason for your answer. [2]

- (c) Based on the given data, which glass, A, B, C or D, is suitable to be made into a camera lens? [1]

SCORE	3
-------	---

36. Linda prepared the following set-up and blew into the straw.

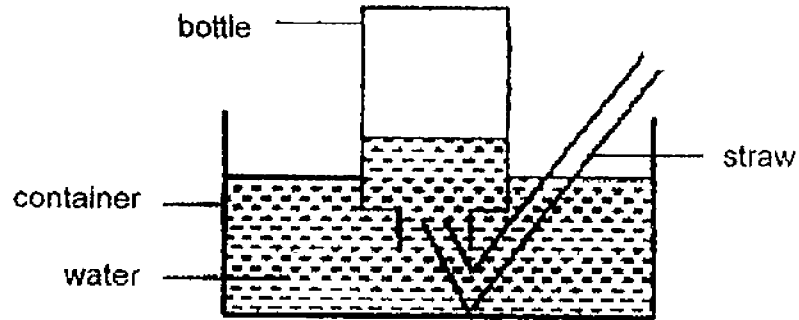

(a) What would happen to the water level in the bottle when Linda blew into the straw? Explain your answer. [2]

Linda cut a hole in the bottle as shown in the diagram below.

(b) Draw the water level in the bottle in the diagram below. [1]

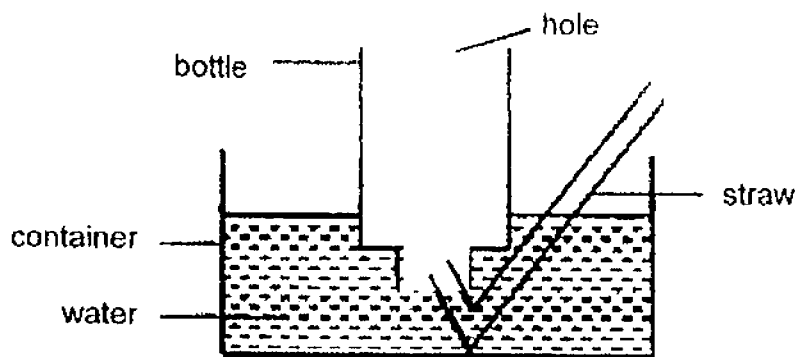

(c) Explain your answer in (b) [1]

SCORE	4
-------	---

37. Siti prepared 4 set-ups, W, X, Y and Z, using identical containers filled with water. The table below shows the different conditions that the set-ups were exposed to, at the start of the experiment.

	Experiment			
	W	X	Y	Z
Temperature of room	25°C	25°C	25 °C	30°C
Volume of water (cm ³)	300	300	500	300
Presence of wind	Yes	No	No	Yes

Based on the information above, answer the following questions:

- (a) At the end of the experiment, which set-up will have the least amount of water left?

[1]

- (b) If Siti wanted to investigate how the rate of evaporation of water was affected by the presence of wind, which of the above set-ups should she use?

[1]

SCORE	
-------	---

38. The diagram below shows a watercone which is a water collecting device.



The diagram below shows how water is being collected in the watercone.

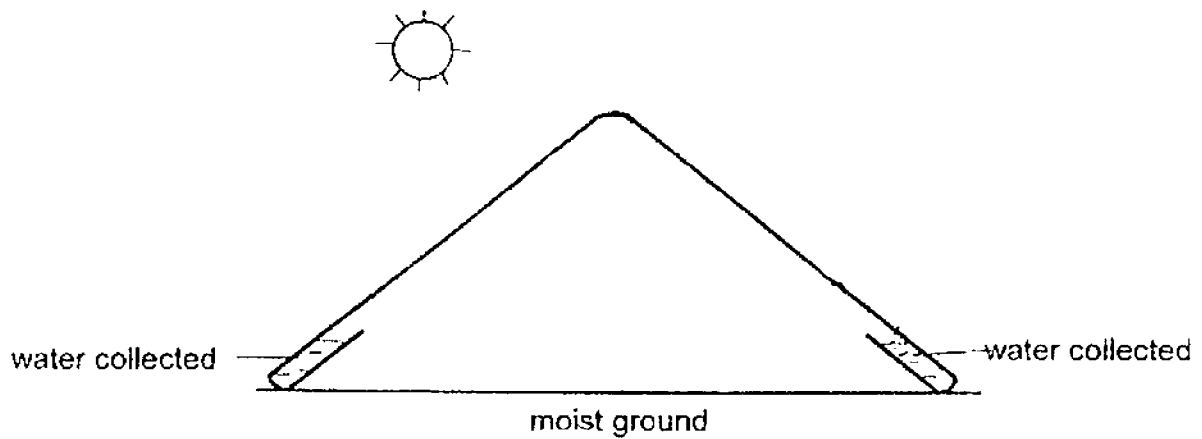

(a) Explain how water is being collected in the watercone. [2]

) Under normal weather conditions, 2 litres of water can be collected by the Watercone. When there is a drought would the amount of water collected be less than or more than 2 litres. Explain your answer. [2]

SCORE	4
-------	---

39. Kevin sets up an experiment to use a light sensor to count the number of identical object P on a moving belt which moves at a constant speed. Objects P do not allow light to pass through it. When object P is between the light source and the sensor, it blocks the light from reaching the sensor.

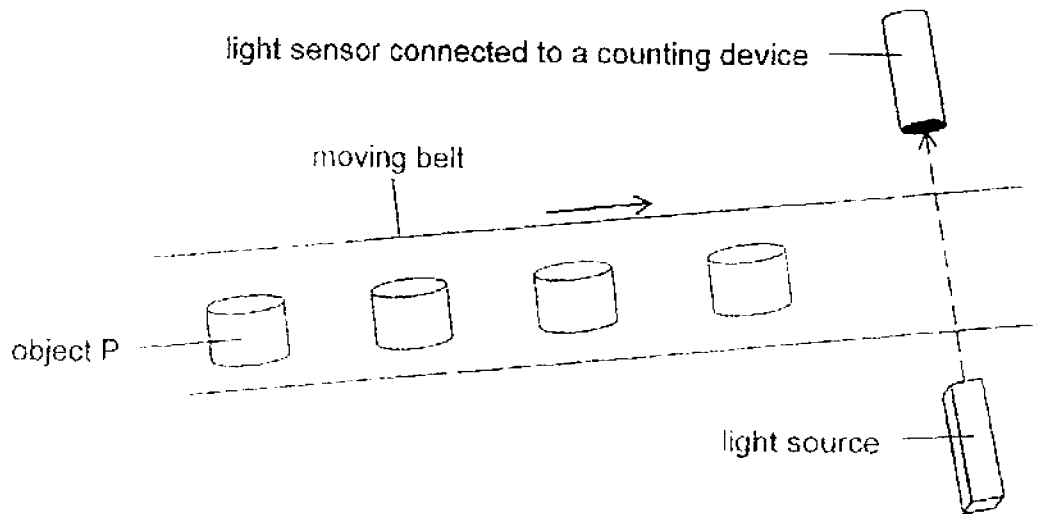

The height of object P is 10 cm. Kevin places the light source and sensor 15 cm above the belt respectively.

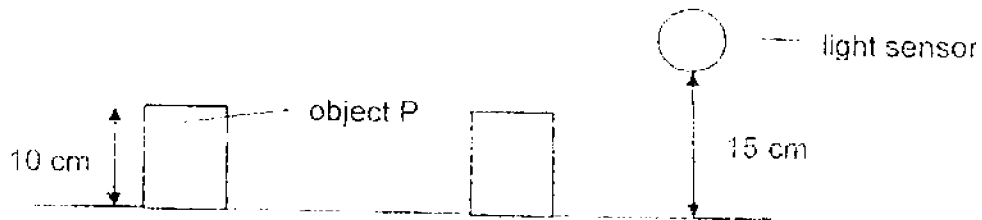

He records the data as shown below.

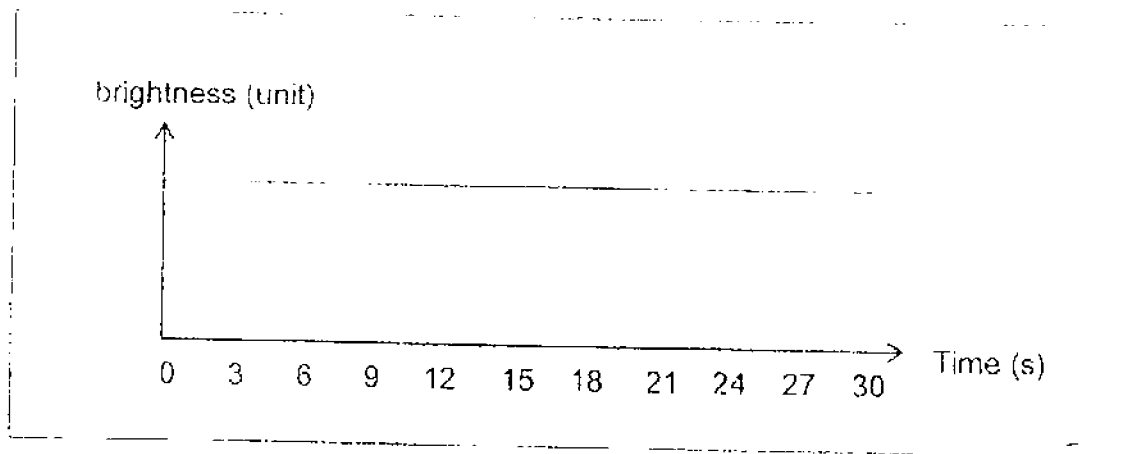

Continue from Question 39

- (a) When the light source and sensor are placed 15 cm above the belt, Object P cannot be counted. Explain why. [2]

- (b) Without replacing object P, suggest two changes Kevin can do to the set-up shown above so that object P can be counted. [2]

(i) _____

(ii) _____

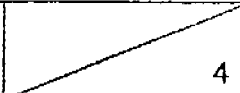
SCORE	
-------	---

40. Karen placed identical test tubes, A and B, filled with equal amount of water at different temperatures in identical containers of water at room temperature as shown below.

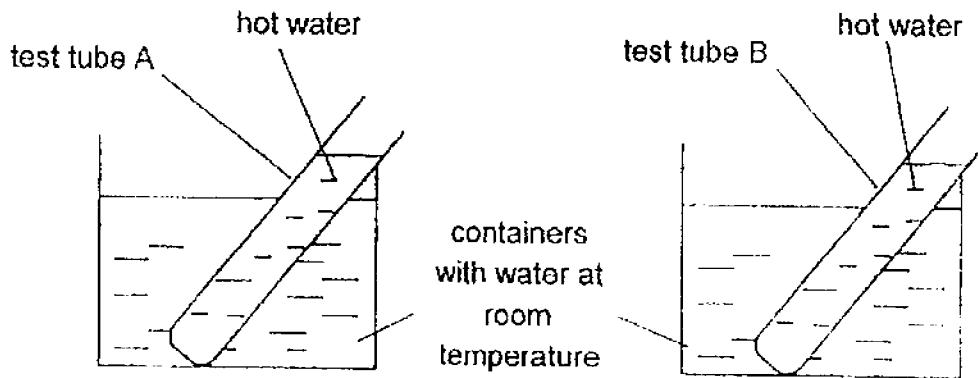

After 30 minutes, she started to record the temperature of the water at every 10 minutes interval.

Duration (min)	Temperature of water in test tube (°C)	
	A	B
30	32	30
40	30	30
50	30	30

- (a) Based on the information above, what is the room temperature? [1]

- (b) Which test tube contained water of a higher temperature at the start of the experiment? Give a reason for your answer. [1]

SCORE	2
-------	---

41. Jenny used identical burners to heat up rods made of materials A and B. She recorded the time taken for the wax to melt and the nails to drop.

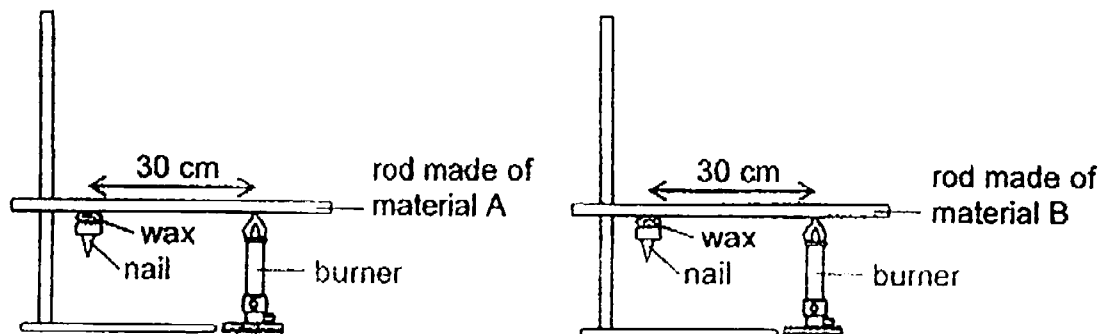

- (a) Why did the wax in both set-ups melt after the burners were lit for some time? [1]

- (b) State another variable that should be kept the same in the two set-ups. [1]

- (c) The time taken for the wax to melt and nail to drop off is recorded in the table below.

Rod used	Time taken (min)
rod made of material A	3
rod made of material B	7

- Which material is more suitable to make a cooking pot? Explain your answer. [2]

THE END

EXAM PAPER 2016 (P5)

SCHOOL : RAFFLES GIRLS'

SUBJECT : SCIENCE

TERM : SA1

Q1	Q2	Q3	Q4	Q5	Q6	Q7	Q8	Q9	Q10
2	1	1	2	3	4	4	3	2	2
Q11	Q12	Q13	Q14	Q15	Q16	Q17	Q18	Q19	Q20
1	2	1	4	2	2	1	2	1	2
Q21	Q22	Q23	Q24	Q25	Q26	Q27	Q28		
1	4	1	2	1	1	4	2		

29) Bird

Fish

Reptile

P,R

T

S,Q

30)a) At stage A the nymph of the cockroach does not live in the water but the larva of the mosquito lives in the water and At stage A the nymph have wings but the larva does not have wings.

b) The adult stage. The mosquito can fly away and would not be able to be caught as it has wings at adult stage therefore it was challenging.

31)a) Type of seeds used

Number of seeds used

Location of set-ups

31)b)No. I do not agree with Ali. Seeds need warmth to grow and there is no warmth in a freezer, so the seed will never germinate after a few days.

32)a)Tom inherit trait A from his mothers.

b)2 siblings.

c)The nucleus of the cell carries information of trait A.

33)a)As the surface area of structure H of the fruit increases, the longer the time taken by the fruits to reach the ground.

b)Plant P. The fruits with structure H has wing-like structures and so it gets dispersed by wind. It is also far apart from its parent plant and follows the wind direction, therefore plant P have fruits with structure P.

c)It has a light weight.

d)Plant R. The young plants of plant R are clustered together.

34)a)They both have a cell wall.

b)Part B. It has chloroplast that contains chlorophyll to trap light and make food for the plant and part B's function is to make food.

35)a)So that his result reliable.

b)Glass A. It allow the least amount of light to pass through it.

c)Glass B.

36)a)The water level will decrease. The air blown into the bottle will displace the water and occupy the space which was previously occupies by the water.

b)

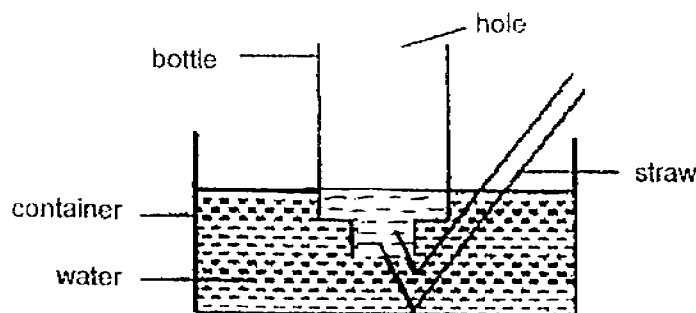

36)c)The air in the bottle will escape through the hole and the water from the container will enter the bottle and rise to the same level as the water level in the container.

37)a)Set-up Z.

b)Set-up W and X.

38)a) The water vapour lost heat and condensed into water droplets on the cooler inner surface of the water cone, one water droplets then flow along the cooler inner surface of the water cone and is collected at the sides.

b)During droughts there will be less water present on the ground to be evaporated into water vapour therefore with the reduced amount of water vapour condensed into water droplets on the cooler water cone, less water will be added.

39)a)The light sensor might count on how much light can pass through the belt and not object P and just by luck that the belt might have the same amount of light that can pass through as object P.

b)i)Lower the light source by 5/10cm above the belt.

ii)Lower the light sensor by 5/10cm above the belt.

40)a)30°C

b)Test tube A. The water in test tube A took a lower time to lose heat to water in container to reach room temperature at 30°C hence it contained water of higher temperature at the start.

41)a)The wax gains heat from the burner through the heated Rod.

b)Size of wax.

c)Material A. Material A is a better conductor of the wax on rod made of material A gained heat from heat source and melted faster hence the pot made of material A will allow the heat to be conducted from the flame to food faster to cook.